

Instructions for Use Installation and Servicing

To be left with the user

Glow•worm

115-150-175-200-250-300

Unvented hot water
storage cylinders

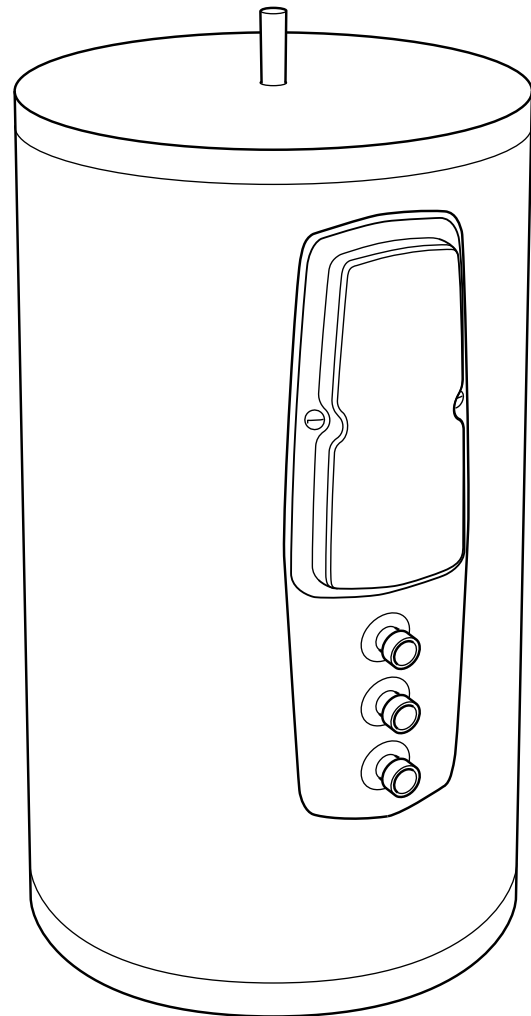

12563



Guarantee Registration

Thank you for installing a new Glow-worm cylinder in your home.

Glow-worm appliances' are manufactured to the very highest standard so we are pleased to offer our customers' a Comprehensive Guarantee.

We recommend you complete and return your Guarantee Registration Card as soon as possible.

If this card is missing you can obtain a copy or record your registration by telephoning Glow-worm's own service organisation on 01773 828100.

Our Guarantee gives you peace of mind plus valuable protection against breakdown.

For customer service call:

01773 828100

Technical helpline: 01773 828300

For General and Sales enquiries:

Tel. 01773 824141

Fax: 01773 820569

To register your Glow-worm appliance call:

0800 073 2142



Contents - Testing and Certification

The instructions consist of three parts, User, Installation and Servicing Instructions. The instructions are an integral part of the appliance and must, to comply with the current issue of the Gas Safety (Installation and Use) Regulations, be handed to the user on completion of the installation.

CONTENTS		
1	Description	4
1.1	DHW Temperature Control	4
1.2	CH Control	4
1.3	Immersion Heater	4
1.4	Applications	4
1.5	Typical applications	4
1a	Technical Data	4
2	Instructions for use	6
2.1	Introduction	6
2.2	Liability	6
2.3	How to use your Glow-worm hot water cylinder	6
2.4	Immersion heater	6
2.5	Important notes	6
2.6	Guarantee	7
3	Note To Installer	8
3.1	Secondary System	8
3.2	Secondary Return	8
4	Installation	8
4.1	Installation requirements	8
4.1.1	Siting	8
4.1.2	Mains Water Pressure	8
4.1.3	Pipework – Primary Circuit	9
4.1.4	Discharge Pipework	9
4.1.4.1	High Level Termination	10
4.2	Dimensions	10
4.3	Functional diagrams	11
4.4	Installation procedure	12
4.4.1	Primary pipework	12
4.4.2	Secondary system Pipework	12
4.4.3	Safety valve discharge pipework	12
4.4.4	Drain Valve	13
4.4.5	Electrical connections and controls	13
4.4.5.1	Immersion Heater	13
4.4.5.2	Electrical Connections and Controls	13
4.4.5.3	Control options – system wiring scheme	14
5	Commissioning	16
5.1	Filling Secondary DHW Circuit	16
5.2	Filling the Primary Circuit	16
5.3	Operating the Boiler	16
5.4	Benchmark Log Book	16
5.5	User's Instructions	16
6	Maintenance	16
7	Fault finding	17

Testing and Certification

This product has been assessed and found to comply with the requirements of the Building Regulations for unvented hot water storage systems and must not be altered or modified in any way.

Any alteration not approved by Glow-worm, could invalidate the certification, warranty and may also infringe the current issue of the Statutory Requirements.

WARNING: We cannot accept responsibility for any damage which may occur as a result of non-observance of these instructions.

Subject to alteration.

Spare Parts **REMEMBER:** Use only genuine spare parts supplied by Glow-worm.

1 Description

The Glow-worm range of unvented hot water storage cylinders are indirectly heated cylinders which are designed for use with UK standard boilers in hot water supply systems.

Glow-worm cylinders are available in six sizes; 115, 150, 175, 200, 250 and 300 litre. The cylinders are of stainless steel construction, insulated with EPS and enclosed in a decorative casing. They are supplied with all necessary cold and hot water controls and a 2 port valve for control of domestic hot water.

The Glow-worm cylinders operate using a mains water pressure supply and do not require a feed from a cold water storage tank. The Glow-worm cylinders have 22 mm DHW outlet and cold water mains inlet connections for optimum flow rate. To achieve optimum performance from the Glow-worm cylinder an adequate cold water mains supply pressure and flow rate must be available (see section 4.1.2: Mains Water pressure).

1.1 DHW Temperature Control

The Glow-worm cylinder is supplied fitted with a user adjustable domestic hot water (DHW) thermostat which controls a 2 port motorised valve and hence the temperature of the water in the Glow-worm cylinder.

1.2 CH Control

Central heating is controlled by a separately fitted 2 port valve in conjunction with suitable external controls, such as a programmer, room thermostat or thermostatic radiator valves. The external electrical controls should be wired to the 2 port valve and cylinder thermostat in the normal way, as shown in the section Electrical Connections and Controls.

1.3 Immersion Heater

Glow-worm cylinders are also provided with an auxiliary back up 3kW electric immersion heater, including operating thermostat and energy cut out.

The immersion heater is fitted behind the front panel. It is designed for use in unvented installations and contains a safety overheat thermostat in addition to the operating thermostat.

NOTE: Only the correct immersion heater containing a safety overheat thermostat may be used for replacement.

1.4 Applications

The Glow-worm cylinder can be connected to any UK standard boiler.

1.5 Typical applications

Single bathroom property:
Glow-worm cylinder 115

Single bathroom property with an en-suite shower room:
Glow-worm cylinder 115 / 150

Two bathroom property:
Glow-worm cylinder 150 / 175

Two bathroom property with an en-suite shower room:
Glow-worm cylinder 175 / 200

Larger properties:
Glow-worm cylinder 250 / 300

Commercial use: size depending upon hot water requirements

NOTE 1: Select the appropriate boiler to match the heating load (with the normal allowance for heating up from cold) plus an allowance for heating the hot water cylinder. Typically it is practice to allow an additional 2-3kW for the hot water production.

NOTE 2: Consideration should be given to the use of a larger size of cylinder than shown above where high water demands are likely.

1a Technical Data

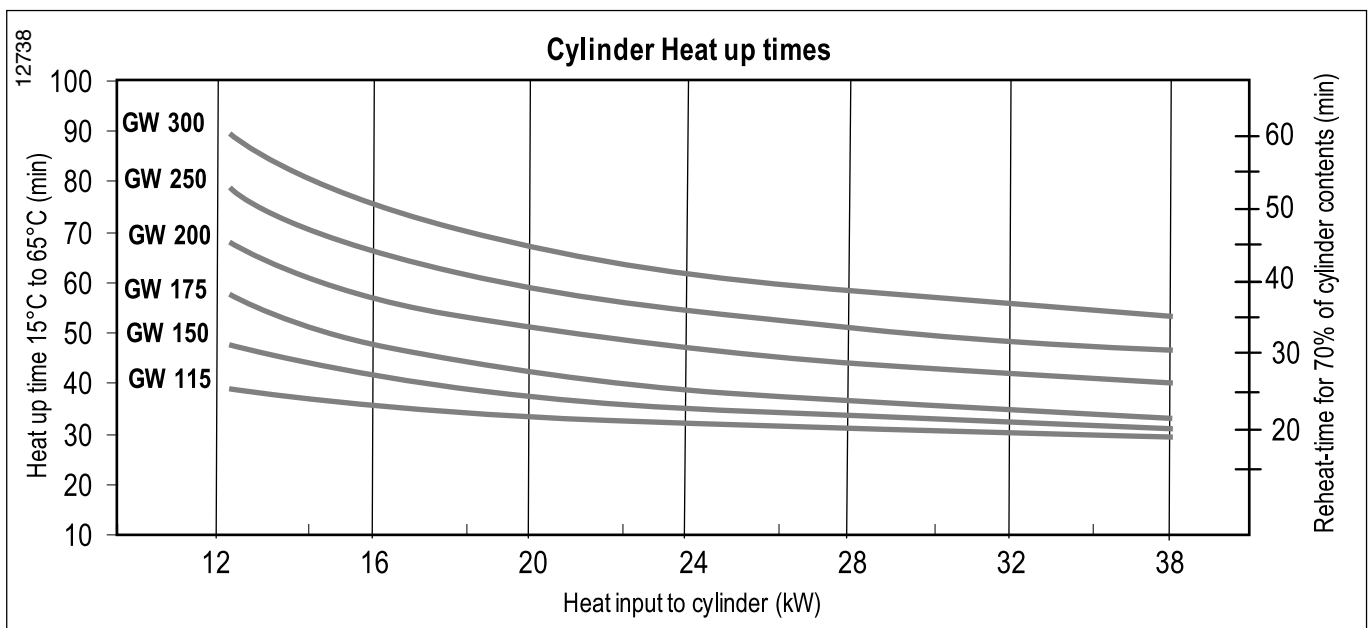

1a Technical Data

	GW 115	GW 150	GW 175	GW 200	GW 250	GW 300	Unit
Size	115	150	175	200	250	300	litres
Nominal DHW flow from GW 115/150/175/200	15 l/min @ 60°C						
GW 250/300	20 l/min @ 60°C						
Maximum water supply pressure	10						bar
Maximum primary circuit pressure	2.5						bar
Expansion vessel charge pressure	4						bar
Operating pressure	3.5						bar
Pressure reducing valve	3.5						bar
Expansion relief valve	6.0						bar
T/P valve	95 / 7.0						°C/bar
Net weight	28	30	33	39	44	49	kg
Weight (full)	145	175	205	245	310	340	kg
Height	969	1179	1339	1499	1789	2109	mm
Cylinder connections:							
Cold mains inlet	22 mm compression						
DHW outlet	22 mm compression						
Balanced pressure cold water outlet	22 mm compression						
Secondary return	G ³ / ₄						
Primary flow	22 mm compression (on 2 port valve)						
Primary return	22 mm compression						
Electrical connections:							
3 kW Immersion heater	230/240 V, 50 Hz						
Three port valve	230/240 V, 50 Hz						
Cylinder thermostat	230/240 V, 50 Hz						
Coil Specifications:							
Heat loss	1.7	1.9	2.0	2.1	2.3	2.5	kW/24h

NOTE: Heat up time based on a primary flow rate of 15 l/min at 82°C.
Temperature rise is from 15°C to 65°C for 70% of the cylinder volume.

2 Instructions for Use

2.1 Introduction

Your Glow-worm unvented hot water cylinder and boiler, together provide you with a modern, efficient, high performance heating and hot water system.

Because your Glow-worm hot water cylinder is supplied with water directly from the mains, you get the benefit of mains pressure hot water at your hot taps, without the need for storage tanks in the loft and without a hot water pump. The Glow-worm cylinder is made from high quality stainless steel within an easy clean casing. The cylinder is fully insulated using environmental friendly EPS insulation to help keep your hot water running costs at a minimum, and protect the environment!

Your Glow-worm cylinder is tailor made to accompany a Glow-worm boiler as well as any other UK standard boiler. All Glow-worm boilers are equipped with 'built-in' energy saving technology, such as burner modulation, anti cycling control and high efficiency heat exchangers.

Please read these instructions carefully to ensure that you get the very best out of your heating and hot water system.

2.2 Liability

WARNING: We can accept no liability whatsoever for damage or injury resulting from failure to observe these instructions.

Specified use

Glow-worm Glow-worm unvented cylinders are made to fulfil the latest technical specification and official safety regulations. These cylinders are designed for use with UK standard boilers for use in hot water supply systems.

Use of this type is entirely at the owner's risk.

The term 'specified use' also covers observance of the operating and installation instructions, along with adherence to the servicing schedules. The Benchmark logbook, one for both boiler and cylinder, should be completed by the installer and/or commissioning engineer and handed to the user. All CORGI registered installers carry a CORGI ID card and have a registration number. Both should be recorded in your Benchmark logbook. You can check your installer by calling CORGI direct on 01256 372300.

NOTE: Your Glow-worm unvented hot water cylinder must be installed by a competent person in accordance with current Building Regulations. Do not remove or adjust any component part of this cylinder. In the unlikely event that your Glow-worm develops a fault, such as a flow of hot water from the discharge pipe, switch the boiler and immersion heater off and contact Glow-worm or your installer.

NOTE: If the Glow-worm cylinder is installed in a cupboard used for airing purposes please ensure that clothing or other articles are not placed on the cylinder or its associated controls.

NOTE: Access should always be maintained to allow operation of the domestic hot water thermostat control.

2.3 How to use your Glow-worm hot water cylinder

Your boiler and Glow-worm unvented hot water cylinder will provide both central heating and mains pressure hot water.

Check that the boiler is operational as detailed in the instructions for use supplied with the boiler.

The domestic hot water thermostat on the Glow-worm cylinder can be set from 20°C to 65°C. The desired temperature will be set by the installer while commissioning the Glow-worm cylinder (normally a setting of 60°C is adequate).

NOTE: In hard water areas the DHW temperature selected should not exceed this setting to avoid possible scale build-up.

If a programmer has been fitted to control the central heating and hot water, check that this is set to the desired on and off periods.

The boiler will then operate automatically to heat the cylinder contents at the desired times to the temperature selected. When domestic hot water is used, the boiler will operate to re-heat the cylinder as required.

2.4 Immersion heater

The electric immersion heater behind the front panel is provided as a back up means of water heating and is not intended for use at the same time that the boiler is heating the cylinder.

2.5 Important Notes

Shutting down the Glow-worm cylinder

To shut down the heating and hot water system for short periods, simply turn off the boiler as shown in the instructions supplied with the boiler.

Frost protection

Please ensure that if you are absent during a period of frost the central heating system remains in operation and the rooms and Glow-worm cylinder are kept above freezing point. It must be remembered however that the boiler will be automatically switched off by built-in monitoring devices if certain faults occur, e. g. interruption in the gas or electricity supply.

Alternatively you can drain the central heating system, boiler and Glow-worm cylinder. Please contact your Installer.

Care and Maintenance

The casing of the Glow-worm cylinder may be cleaned with a damp cloth and a little soap. Do not use any abrasive or solvent material which could damage the case or fittings.

It is important that your hot water cylinder is serviced annually by a competent person. Please contact your installer or Glow-worm 01773 828100 for further details.

2 Instructions for Use

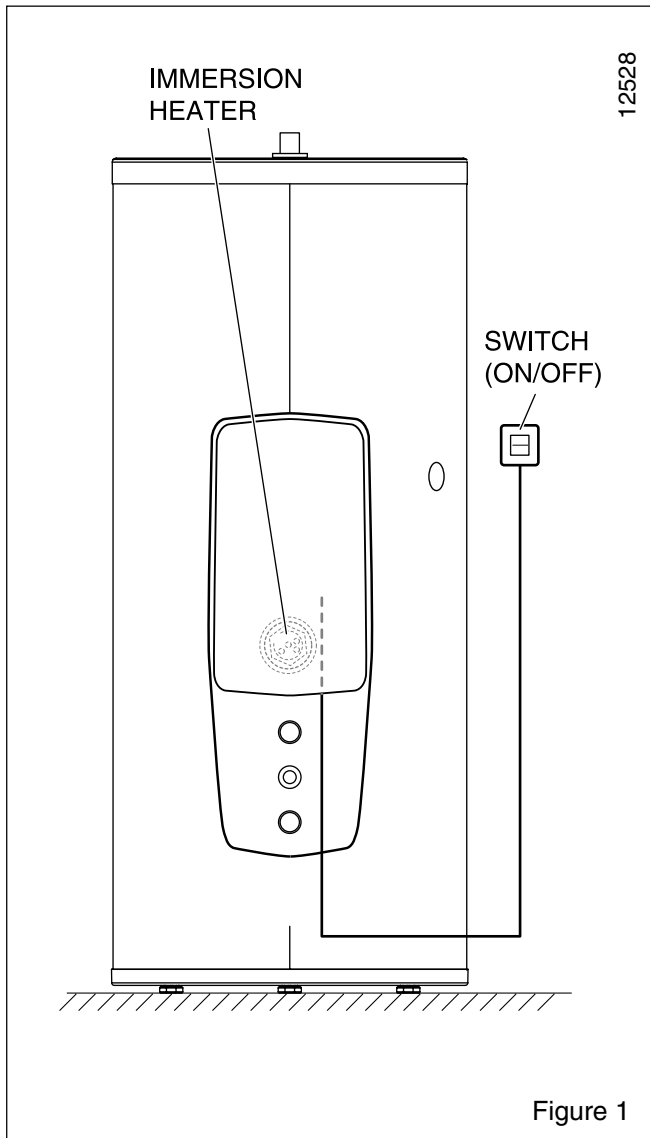

2.6 Guarantee

Glow-worm offers a guarantee of 25 years for the stainless steel vessel against faulty materials or manufacture provided that:

The following information is important as without it your guarantee may be invalid.

1. The warranty will become invalid if the damage is due to scaling, frost damage, transient voltages, lightning strikes or any act of vandalism or mis use
 2. The proof of purchase must be produced in the event of any warranty claim (bill of sale)
 3. The Glow-worm cylinder must be installed by a competent person to the prevailing standards, installation book and building regulations at the time of installation
 4. The benchmark log book must be completed on installation and kept up to date
 5. The Glow-worm cylinder must be serviced annually
 6. The installation must be in an appropriate location and its use is restricted to potable water (chloride levels less than 200 mg/l)
 7. Tampering or modification will invalidate the warranty
 8. The guarantee card must be completed and returned to Glow-worm. within 30 days of purchase
- PLEASE NOTE THIS EXTENDED GUARANTEE IS NOT TRANSFERRABLE AND RESTS WITH THE ORIGINAL HOUSEHOLDER.

For all other Glow-worm parts (electrical, thermal controls, valves and design elements Glow-worm carry a 2 year guarantee.

3 Note to Installer

This product has been assessed and found to comply with the requirements of the Building Regulations for unvented hot water storage systems and must not be altered or modified in any way.

The installation must be carried out by a competent person and be in accordance with the relevant requirements of the Local Authority, Building Regulations, Building Regulations (Scotland), Building Regulations (Northern Ireland), and the bye-laws of the local Water Undertaking. The installation is subject to Building Regulation approval, notify the Local Authority of intention to install. In the event of parts replacement, use only genuine spare parts supplied by Glow-worm.

3.1 Secondary System

The Glow-worm cylinder is provided with all necessary safety and control devices for unvented DHW operation.

These are as follows:

A A prefitted temperature and pressure relief valve (95°C, 7 bar).

B A Thermal cut set at 90°C which when wired to the 2 port valve will isolate the heat source in the event of failure of the cylinder thermostat.

C A cylinder thermostat (20°C - 60°C)

D Expansion relief valve (6.0 bar) incorporating a non return valve.

E Pressure limiting valve (3.5 bar) incorporating a line strainer.

Check that the cylinder has been supplied with the following:

Packed inside cylinder carton

- Water control pack (pressure reducing valve,

expansion relief valve; connections for: balanced cold water, secondary return, expansion vessel)

- Motorised 2 port valve
- Tundish
- Cylinder drain valve,
- Installation and user instructions.

Expansion vessel:

- 12 litre for Glow-worm cylinder 115/150
- 18 litre for Glow-worm cylinder 175/200
- 25 litre for Glow-worm cylinder 250/300

Accessories: Mounting bracket No. 370 214

Prior to installation, ensure that the Glow-worm cylinder is stored upright in dry conditions. The Glow-worm cylinder must be kept

upright during transportation.

Please also refer to "General Requirements" in the installation instructions supplied with the boiler.

3.2 Secondary Return

A secondary return connection is provided in the water control pack.

Connect onto the 1/2" pipe on the control group using a WRAS approved circulation pump which incorporates a check valve to prevent backflow (see fig. 6).

4 Installation

4.1 Installation requirements

4.1.1 Siting

IMPORTANT. With regards to the Manual Handling Operations, 1992 Regulations, the following lift operation exceeds the recommended weight for a one man lift.

Locate the Glow-worm cylinder in the building in the most convenient position ensuring that:

1. The discharge pipe from the tundish can be installed with a minimum fall of 1:200 and must be terminated in a safe and visible position (see section 4.1.4 Discharge pipework).
2. The base chosen for the unit is level and capable of supporting the weight of the cylinder when full (see section 8: Technical Data).
3. The installation site is frost-free. If necessary provide a frost protection thermostat.
4. Access is available for user operation of the DHW temperature control under the front panel.
5. Suitable clearances exist to allow installation, checking and repressurising of the expansion vessel.
6. The installation site chosen does not result in excessive "dead leg" distances, particularly to the point of most frequent use.
7. A suitable cold mains water supply pipe can be provided to the Glow-worm cylinder direct from the main water stop valve of the building.

4.1.2 Mains Water Pressure

The DHW performance of an Glow-worm unvented cylinder installation will correspond to the available mains water supply pressure and flow rate. To achieve optimum performance from the Glow-worm cylinder a suitable cold mains water supply must be available, i. e. the measured static pressure from the incoming mains water supply should be at least 2.0 bar. A corresponding flow rate at least 20-25 l/min should be available.

NOTE: Mains water pressures will reduce during periods of peak demand. Ensure that measurements are taken during these periods.

Example:

If the measured cold mains supply pressure is 2 bar static and the cold mains flow rate available is 30 l/min, the available flow rate of mixed water at 40°C will be 25 l/min (from 15 l/min hot water from the Glow-worm cylinder @ 60 °C together with 10 l/min cold water @ 10°C).

The Glow-worm cylinder will operate satisfactorily with water supply pressures below 2 bar although flow rates will be reduced. If the supply pressure is below 1 bar the Glow-worm cylinder should not be installed. Contact Glow-worm for details on alternative hot water supply systems.

In order to minimise frictional losses minimum 22 mm bore is recommended for new cold mains supply pipework into the dwelling although satisfactory performance can be achieved with 15 mm bore pipework.

4 Installation

4.1.3 Pipework – Primary Circuit

The primary circuit pipework between the boiler and the Glow-worm cylinder should be installed using copper tube of minimum size 22 mm.

If the distance between the boiler and the Glow-worm cylinder is excessive, a larger pipe diameter may be necessary. It will be necessary to install a circulating pump in this pipework if your Glow-worm wall mounted boiler does not contain a built-in circulating pump.

If the Glow-worm cylinder will be used with any other UK Standard boiler a suitable pump must be fitted into the primary circuit.

4.1.4 Discharge Pipework

The outlet connections of both the temperature and pressure relief valve and expansion relief valve should be connected in 15 mm copper tube to the tundish supplied.

The tundish should be installed vertically, as close to the Glow-worm cylinder as possible and within 500 mm of the temperature and pressure relief outlet. It must be positioned away from any electrical components and installed in the same space as the Glow-worm cylinder, so that it is visible to the user.

The D1 discharge pipe from the T&S Valve/Expansion Valve can be teed together upstream of the tundish, see fig 6. The discharge pipework must be installed using minimum 22 mm copper pipework from the 1 inch BSP female connection on the tundish to a safe and visible discharge point. There must be a vertical section of pipe at least 300 mm long, below the tundish before any bends or elbows in the pipework. Increase the diameter of the pipework if the total resistance of the discharge pipework exceeds the figures shown in the table below.

The installation of the discharge pipework must be in accordance with G3, see fig 2.

Minimum size of discharge pipework from Tundish	Maximum total resistance allowed expressed as a length of straight pipe (i.e. no elbows or bends)	Resistance created by each elbow or bend
22 mm	up to 9 m	0.8 m
28 mm	up to 18 mm	1.0 m
35 mm	up to 27 mm	1.4 m

Example

22 mm discharge pipe having 4 elbows and a length of 7 m from the tundish to the discharge point:

Resistance for 4 elbows

at 0.8 m each = 3.2 m

Resistance of discharge pipe = 7.0 m

Total Resistance
= 10.2 m

The total resistance of the discharge pipework is greater than the maximum allowed for 22 mm pipework (9 m). Therefore calculate the next largest size.

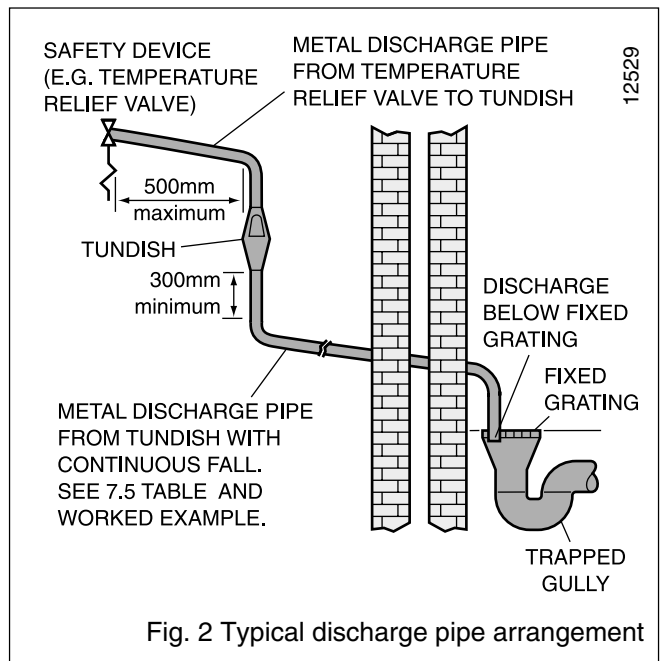

Fig. 2 Typical discharge pipe arrangement

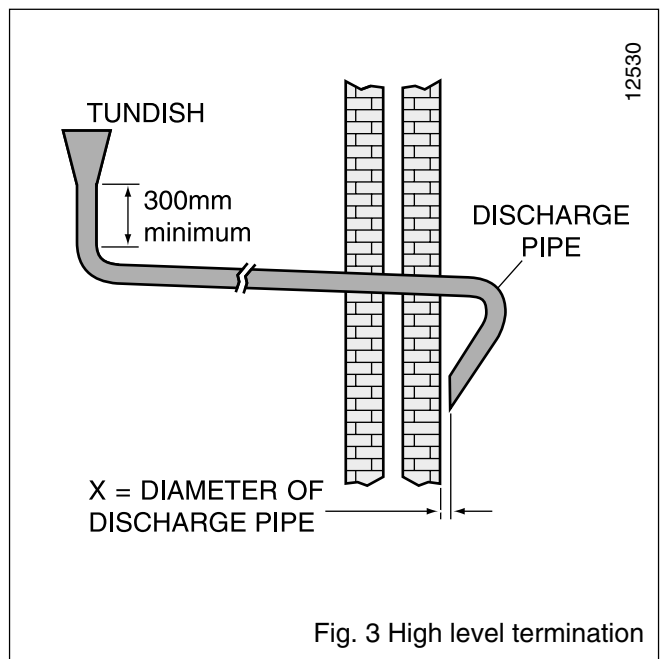

Fig. 3 High level termination

28 mm discharge pipe with 4 elbows and 7 m length from tundish to discharge point.

Resistance for 4 elbows

at 1.0 m each = 4.0 m

Resistance of discharge pipe = 7.0 m

Total Resistance
= 11.0 m

The total resistance of the discharge pipework is less than the maximum allowed for 28 mm pipework (18 m) therefore the discharge pipework size is acceptable.

Under fault conditions, the discharge warning pipe can emit water at near boiling temperature. Ensure the discharge pipe terminates at a safe position where there is no risk of contact with hot water by persons in or about the building (safe and visible).

A suitable position for the discharge point is ideally below a fixed

4 Installation

grating and above the water seal in a trapped gully. Downward discharges at low level, i. e. up to 100 mm above external surfaces such as car parks, hard standings, grassed areas, etc. are acceptable providing that where children may play or otherwise come into contact with discharges a wire cage or similar guard is positioned to prevent contact, whilst maintaining visibility.

Do not fit any valves or taps to the discharge pipework. Ensure the pipework has at least 1:200 fall continuously from the tundish to the discharge point.

The discharge pipe from the pressure relief valve of the boiler may be teed-into the discharge pipework from the Glow-worm downstream of the tundish in the horizontal pipework.

4.1.4.1 High Level Termination

Providing that the point of termination is such that persons in or around the building will not be endangered should discharge take place, the method of termination shown in fig. 8a is

satisfactory. Examples of points to consider when deciding whether a location for the high level discharge is suitable are:

1. The possibility, taking into account wind effect, that someone may be in the path of the water being discharged and if so, whether the temperature of the discharge water will have been sufficiently reduced to not be dangerous. Thermal conductivity of the structure's surface, climatic conditions and location and orientation of the discharge pipe may or may not have an effect on reducing the temperature of the discharge water.
2. The location of windows and similar openings.
3. The likelihood of a pram being left beneath the point of discharge.
4. The ability of the structures surface to withstand near boiling water.
5. The possibility of ice formation if water is discharged onto pedestrian walkways.

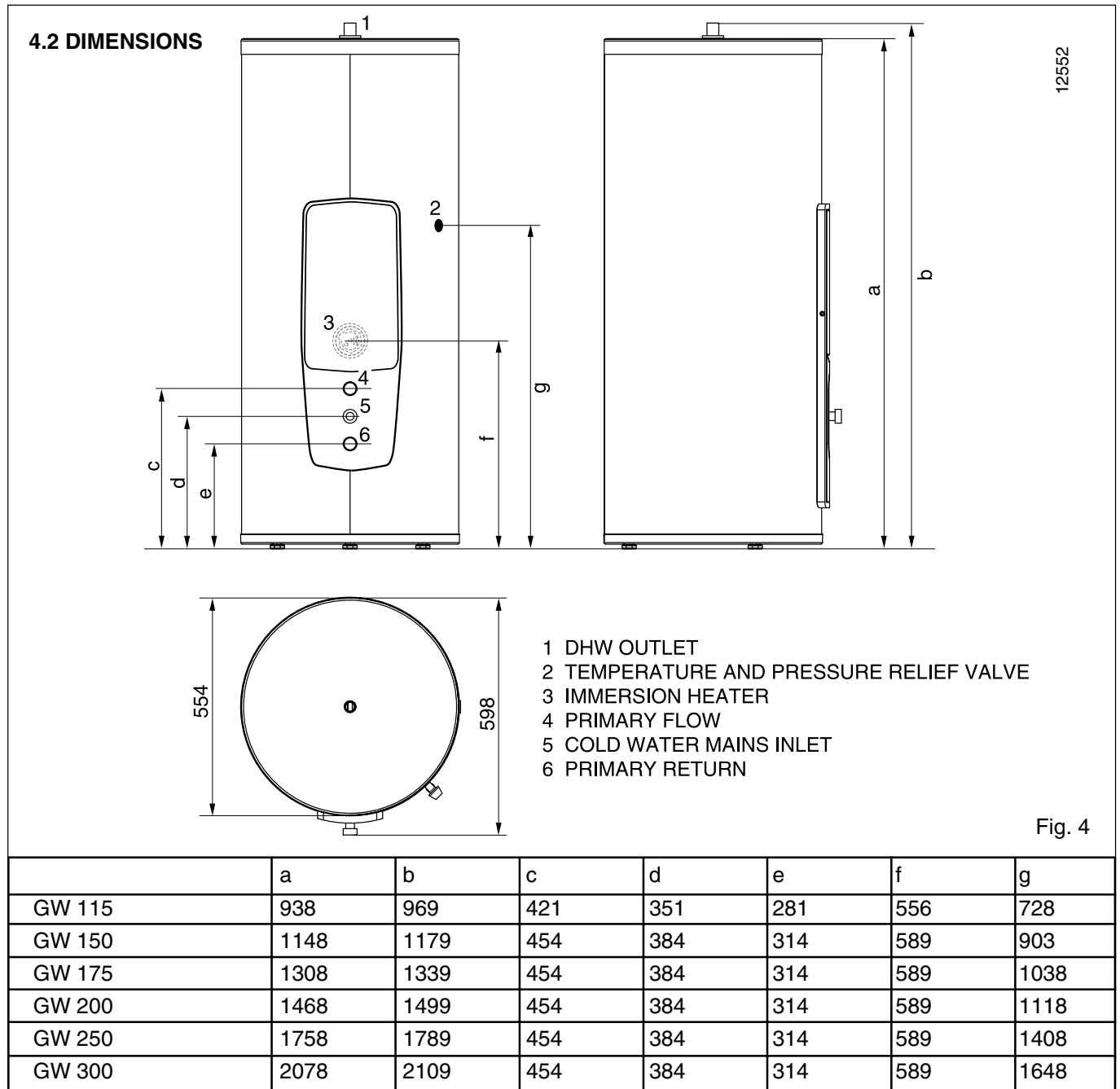

4 Installation

12553

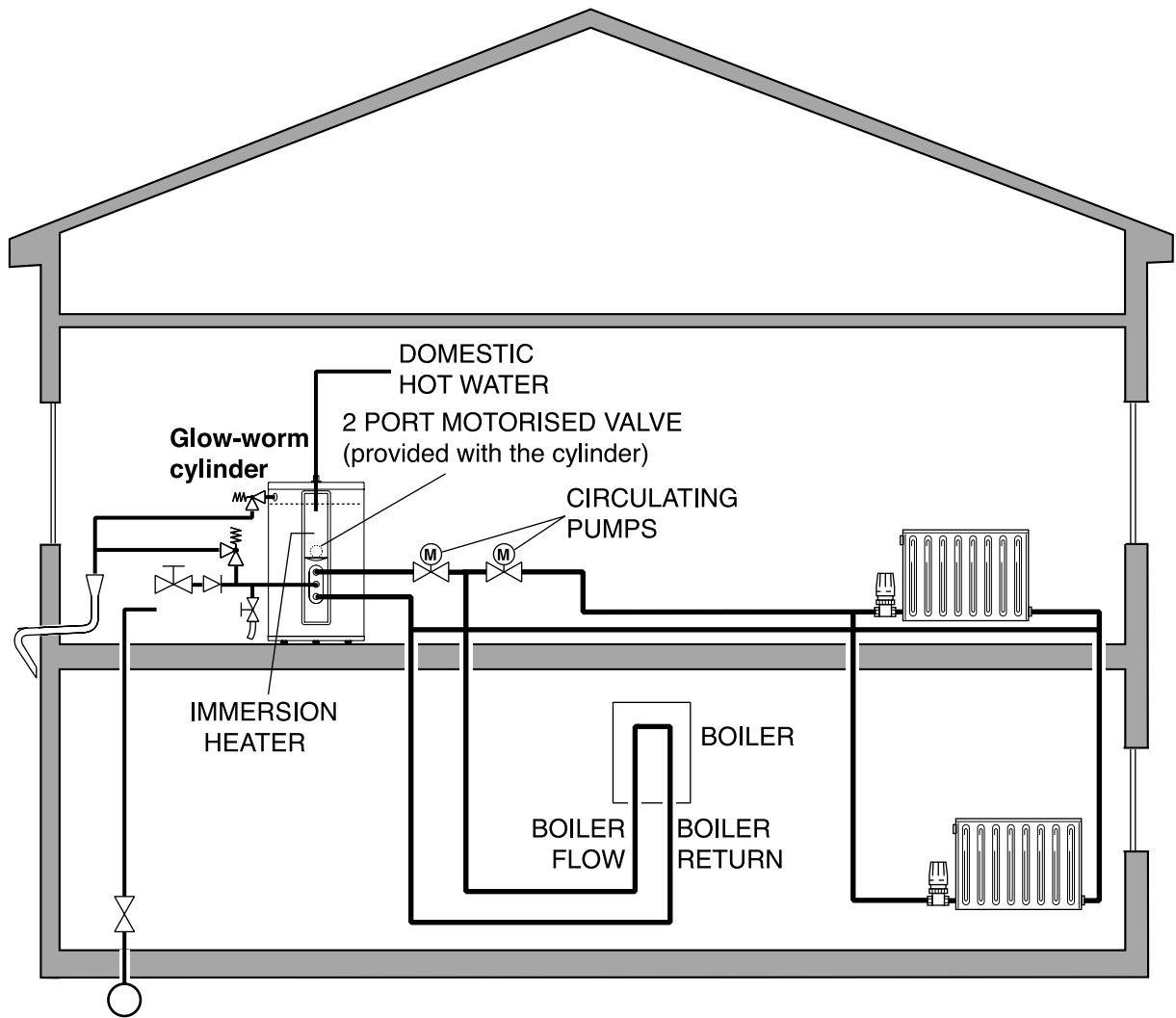

4.3 FUNCTIONAL DIAGRAM

Fig. 5

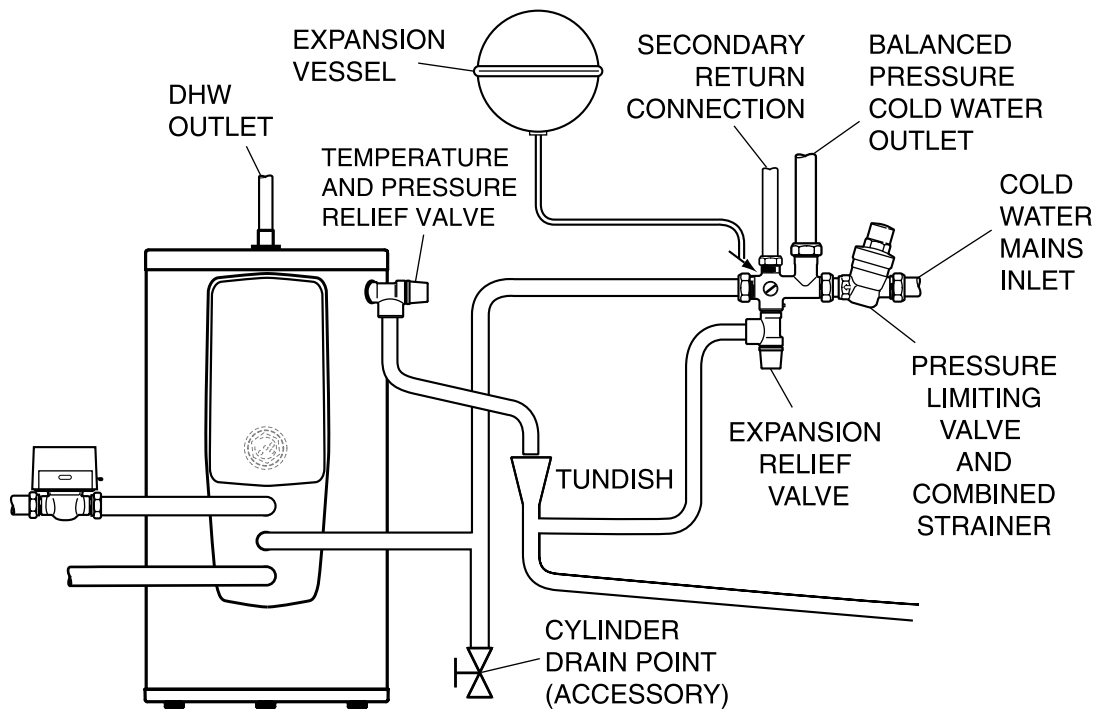

12554

4.3 FUNCTIONAL DIAGRAM

Fig. 6

4 Installation

4.4 Installation procedure

IMPORTANT. With regards to the Manual Handling Operations, 1992 Regulations, the following lift operation exceeds the recommended weight for a one man lift.

Unpack the Glow-worm cylinder and check the contents (detailed in section 3: notes to installers).

Position the Glow-worm cylinder in accordance with section 4.1.1: Siting

4.4.1 Primary pipework

To prevent the Glow-worm cylinder from overheating the 2 port motorised valve supplied with the boiler must be fitted to the primary flow to the indirect coil (see figure 5).

4.4.2 Secondary system Pipework

Connect the two cold water control valves together as shown in fig. 8, ensuring that the orientation of the valves, when installed in the cold mains supply, allows the 15 mm outlet of the expansion relief valve to be connected to the tundish.

Provide a cold water mains supply to the Glow-worm cylinder. To ensure optimum performance from the Glow-worm cylinder, and particularly in installations where the balanced pressure cold water outlet (2, fig. 8) is to be used, the pipework provided from the building mains stop valve to the Glow-worm cylinder should be minimum 22 mm copper tube.

Install the drain valve in the cold mains supply between the Glow-worm cylinder and the cold water control valves at the lowest point.

Install the assembled cold water control valves (fig. 8) in the cold mains supply at a convenient position adjacent to the Glow-worm cylinder, ensuring adequate space exists for service access and allow for connection of the discharge pipe from expansion relief valve.

The Glow-worm cylinder is provided with an external expansion vessel.

Connect the expansion vessel to the installed water controls by either:

- i. Screwing the vessel directly into the control assembly at the purpose provided connection (1, fig. 8) or,
- ii. Connecting the vessel to the control assembly via copper pipe or a suitable approved flexible connection hose, ensuring that the vessel is adequately supported.

NOTE: An optional "Remote Expansion Vessel Mounting Kit" is available for use with Glow-worm cylinders. The kit contains a wall mounting bracket.

Connect the balanced pressure cold water supply (if required) to the cold water control pack (see fig. 8).

NOTE: In areas where the mains water pressure is high (4 bar or above) the cold water supply to a bath or shower mixer valve can be taken from the balanced pressure cold water outlet (2, fig. 8) of the cold water controls. This will ensure that both hot and cold supplies to the mixer valve are at approximately the same pressure. The cold water supply for all other terminal fittings should be teed into the cold water supply pipework to the Glow-worm upstream of the cold water controls.

Connect the DHW outlet pipework to the 22 mm domestic hot water outlet on the Glow-worm cylinder. Continue with 22 mm size pipe to the first tee fitting after which 15 mm pipework should be adequate. If the pipe runs are of excessive length or there are several terminal fittings supplied, extend the length of pipework in 22 mm.

Connect the secondary return if required as shown in 3.2: Secondary Return.

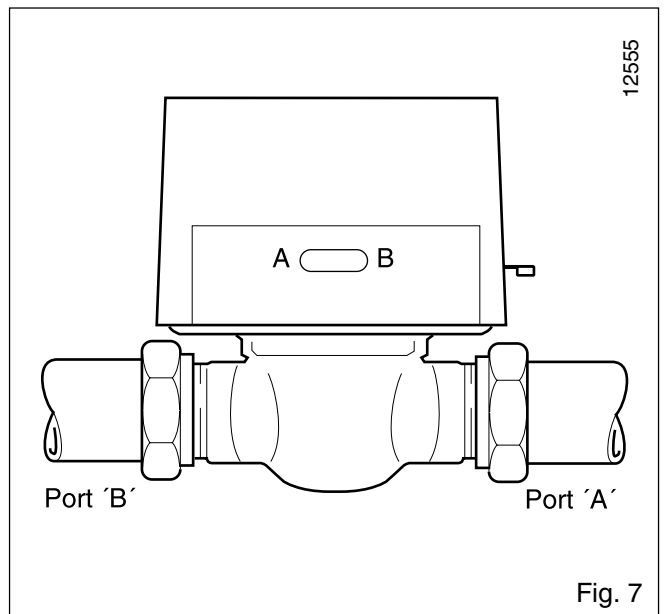
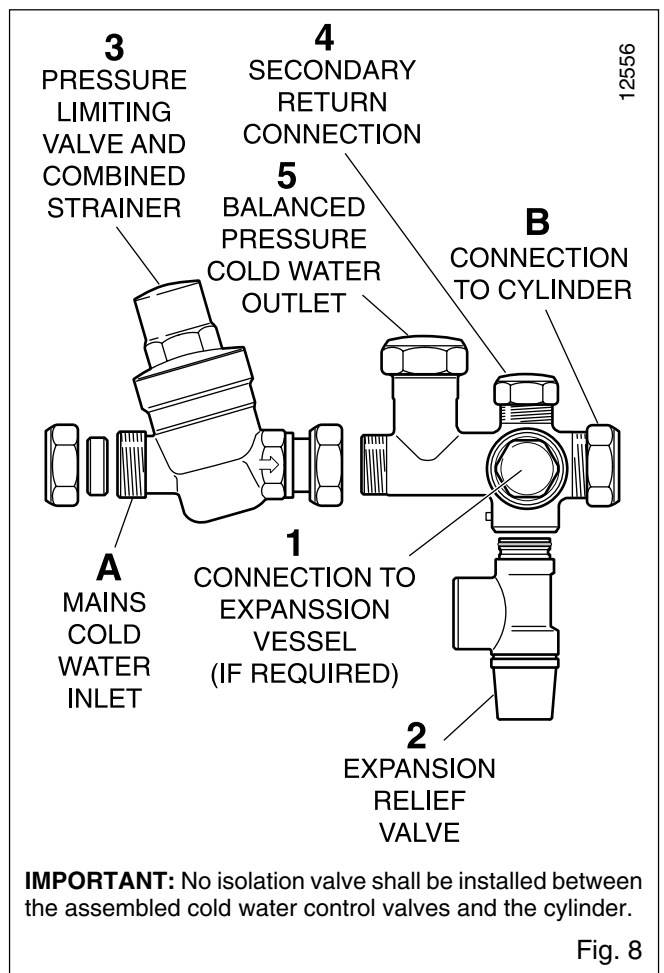

Fig. 7



IMPORTANT: No isolation valve shall be installed between the assembled cold water control valves and the cylinder.

Fig. 8

4.4.3 Safety valve discharge pipework

Connect the temperature/pressure relief and expansion relief valves to the tundish using 15mm pipe and install the discharge pipework from the tundish in accordance with section 4.1.4: Discharge Pipework.

4.4.4 Drain Valve

The drain valve (offered as accessory) has to be fitted in the cold

4 Installation

water mains supply between the Glow-worm cylinder and the cold water control valves as low as possible (see fig. 6)

We recommend to fit a hose pipe in the outlet of the drain valve approximately 1 meter below the bottom of the cylinder (this can be achieved by connecting a suction hose to the outlet of the drain valve).

4.4.5 Electrical connections and controls

All electrical connections conform to BS.

The position of the discharge pipes (tundish), drain valves and motorised valves etc. shall be positioned away from any electrical components.

4.4.5.1 Immersion Heater

The Glow-worm 115 - 300 cylinders are equipped with a factory fitted immersion heater.

All internal wiring is factory mounted.

WARNING: The immersion heater must be earthed.

Install a separate electrical supply to the immersion heater in accordance with the current IEE wiring regulations (BS 7671). The immersion heater must be wired in 2.5 mm² heat-resisting cable from a double pole isolating switch. The circuit must be protected by a 13 amp fuse. The connection details for the immersion heater are shown in fig. 9.

IMPORTANT: The immersion heater incorporates an energy cut-off device and must not under any circumstances be replaced by a standard immersion heater.

Only a correct genuine Glow-worm spare part is permitted.

4.4.5.2 Electrical Connections and Controls

WARNING: The Glow-worm cylinder must be earthed.

The Glow-worm cylinder and accompanying boiler may be controlled using various programmers and room thermostats, details of which are given in section: Control Options.

The Glow-worm cylinder has a prefitted cylinder thermal cut out and thermostat, supplied with 1 m of 3 core and earth flying lead.

All internal wiring is factory mounted.

The thermostat which controls the DHW temperature (see fig. 9) is adjustable between 20 and 65 °C. The built in safety thermal cut out operates at 90 °C. Should the thermal cut out be brought into operation, the motorized 2 port valve will operate and shut the primary flow to the cylinder. Press the reset button (3, fig. 9) to reset thermal cut out and motorised valve.

IMPORTANT: Before resetting the thermal cutout or changing the temperature setting of the thermostat, set the electrical supply off.

Connections to wiring centre

Provide a wiring centre adjacent to the cylinder to make the electrical connections.

Connect the Glow-worm boiler terminals to the corresponding terminals of the wiring centre.

Connect the Glow-worm cylinder controls flying lead and the 2 port valve flying lead to the terminals of the wiring centre.

Connect the terminals of the programmer and room thermostat to the terminals of the wiring centre.

Connect a 3 amp fused mains supply to the terminals of the wiring centre.

NOTE: All wiring must be carried out in accordance with BS 7671: Requirements for electrical installations (IEE Wiring

Regulations, 16th edition).

Check that the sensors from the immersion heater and the cylinder are positioned correctly in the tubes.

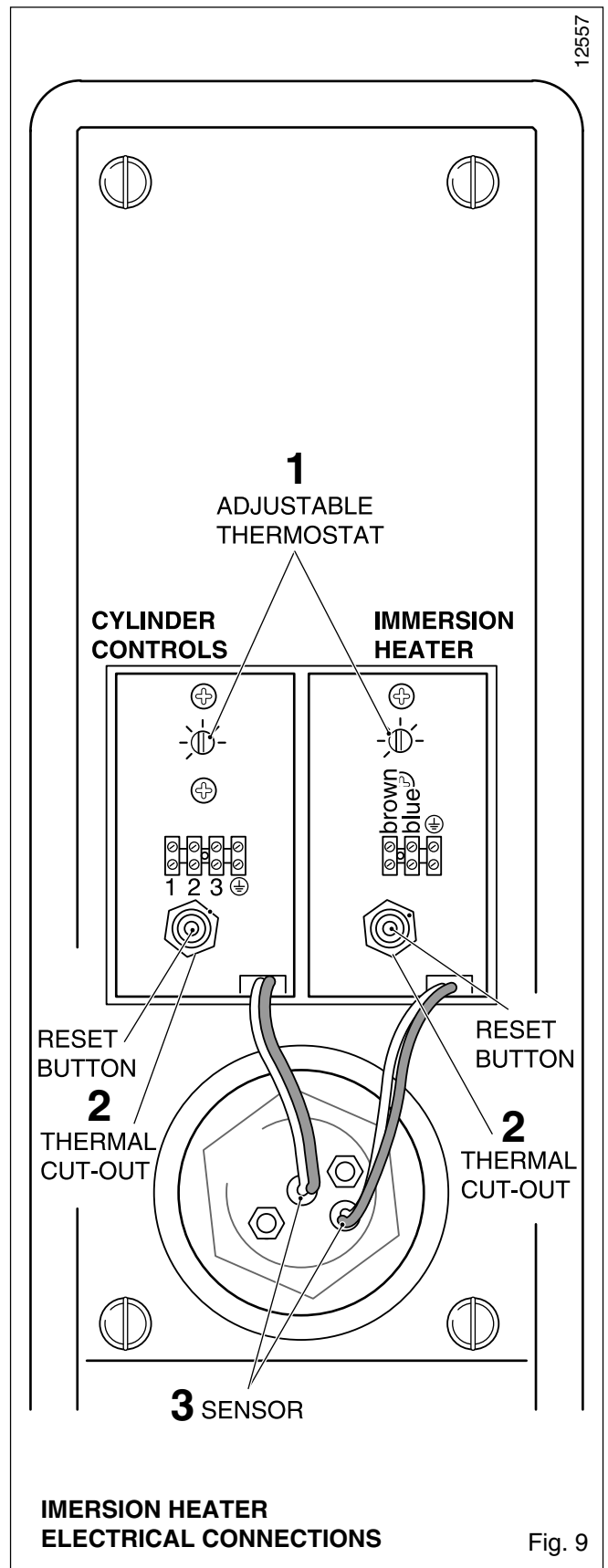

4 Installation

4.4.5.3 Control options – system wiring scheme

12558

★ This valve is required even if a 3 port valve is used.

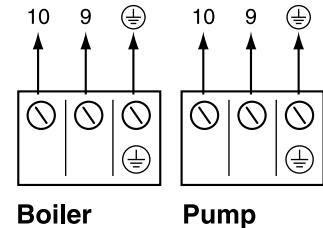
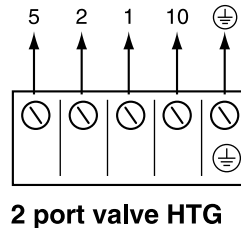
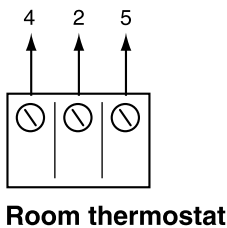
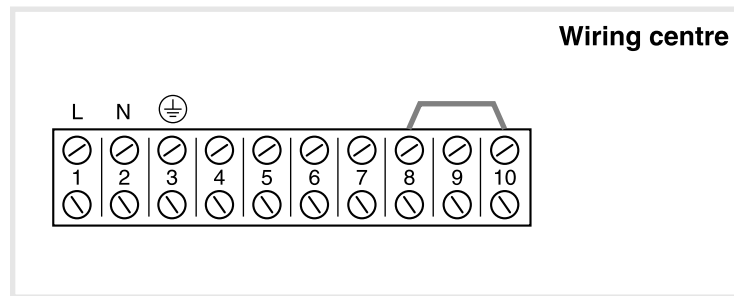
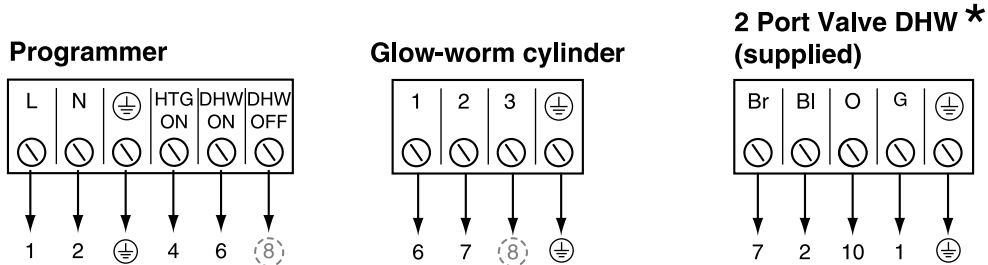

Room thermostat

	2	5	4	E
ACL Drayton Digistat 1		3	1	
ACL Drayton RTS 1, 2	N	3	L	
Danfoss Randall RMT 230	4	2	1	
Danfoss Randall RET 230	N	3	L	
Grässlin Towerchron RS	4	3	1	
Honeywell T6360	2	3	1	
Horstmann HRT 2	4	3	1	
Siemens-Landys & Staefa RAD 1		2	1	
Sunvic TLX 2000 series	4	1	3	
Potterton PRT2	N	H	TL	

If a room thermostat is not used, terminals 4 and 5 of the wiring centre must be linked

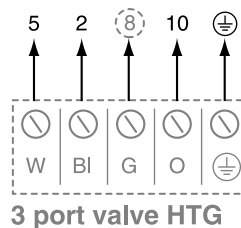

KEY	
Br	Brown
Bl	Blue
G	Grey
O	Orange
W	White
-----	Wiring only for 3 port valve HTG
DHW	Domestic Hot Water
HTG	Heating

IMPORTANT: 1-10 must go to the corresponding number in the wiring centre.

2x2 PORT VALVE SYSTEM

Fig. 10

4 Installation

12559

Lifestyle LP241, LP 522, LP 722	<table border="1" style="margin: auto; border-collapse: collapse;"> <tr><td>N</td><td>L</td><td>1</td><td>2</td><td>3</td><td>4</td></tr> <tr><td>↓</td><td>↓</td><td>↓</td><td>↓</td><td>↓</td><td>↓</td></tr> <tr><td>2</td><td>1</td><td>8</td><td>not used</td><td>6</td><td>4</td></tr> </table>	N	L	1	2	3	4	↓	↓	↓	↓	↓	↓	2	1	8	not used	6	4									
N	L	1	2	3	4																							
↓	↓	↓	↓	↓	↓																							
2	1	8	not used	6	4																							
Tempus 6, Tempus 7	<table border="1" style="margin: auto; border-collapse: collapse;"> <tr><td>E</td><td>N</td><td>L</td><td>1</td><td>2</td><td>3</td><td>4</td></tr> <tr><td>↓</td><td>↓</td><td>↓</td><td>↓</td><td>↓</td><td>↓</td><td>↓</td></tr> <tr><td>⊕</td><td>2</td><td>1</td><td>8</td><td>not used</td><td>6</td><td>4</td></tr> </table>	E	N	L	1	2	3	4	↓	↓	↓	↓	↓	↓	↓	⊕	2	1	8	not used	6	4						
E	N	L	1	2	3	4																						
↓	↓	↓	↓	↓	↓	↓																						
⊕	2	1	8	not used	6	4																						
Danfoss Randall CP 715, FP715	<table border="1" style="margin: auto; border-collapse: collapse;"> <tr><td>E</td><td>N</td><td>L</td><td>1</td><td>2</td><td>3</td><td>4</td></tr> <tr><td>↓</td><td>↓</td><td>↓</td><td>↓</td><td>↓</td><td>↓</td><td>↓</td></tr> <tr><td>*</td><td>2</td><td>1</td><td>8</td><td>not used</td><td>6</td><td>4</td></tr> </table>	E	N	L	1	2	3	4	↓	↓	↓	↓	↓	↓	↓	*	2	1	8	not used	6	4						
E	N	L	1	2	3	4																						
↓	↓	↓	↓	↓	↓	↓																						
*	2	1	8	not used	6	4																						
Note: *Earth not required																												
Grässlin Towerchron QE2, QM2	<table border="1" style="margin: auto; border-collapse: collapse;"> <tr><td>N</td><td>L</td><td>1</td><td>2</td><td>3</td><td>4</td></tr> <tr><td>↓</td><td>↓</td><td>↓</td><td>↓</td><td>↓</td><td>↓</td></tr> <tr><td>2</td><td>1</td><td>8</td><td>not used</td><td>6</td><td>4</td></tr> </table>	N	L	1	2	3	4	↓	↓	↓	↓	↓	↓	2	1	8	not used	6	4									
N	L	1	2	3	4																							
↓	↓	↓	↓	↓	↓																							
2	1	8	not used	6	4																							
Honeywell ST699B, ST799A	<table border="1" style="margin: auto; border-collapse: collapse;"> <tr><td>L</td><td>N</td><td>3</td><td>4</td><td>5</td><td>6</td><td>7</td><td>8</td></tr> <tr><td>↓</td><td>↓</td><td>↓</td><td>↓</td><td>↓</td><td>↓</td><td>↓</td><td>↓</td></tr> <tr><td>1</td><td>2</td><td>4</td><td>not used</td><td></td><td>6</td><td>8</td><td></td></tr> </table>	L	N	3	4	5	6	7	8	↓	↓	↓	↓	↓	↓	↓	↓	1	2	4	not used		6	8				
L	N	3	4	5	6	7	8																					
↓	↓	↓	↓	↓	↓	↓	↓																					
1	2	4	not used		6	8																						
Note: Link L - 5 - 8																												
Honeywell ST6200, ST6300, ST6400	<table border="1" style="margin: auto; border-collapse: collapse;"> <tr><td>N</td><td>L</td><td>1</td><td>2</td><td>3</td><td>4</td></tr> <tr><td>↓</td><td>↓</td><td>↓</td><td>↓</td><td>↓</td><td>↓</td></tr> <tr><td>2</td><td>1</td><td>8</td><td>not used</td><td>6</td><td>4</td></tr> </table>	N	L	1	2	3	4	↓	↓	↓	↓	↓	↓	2	1	8	not used	6	4									
N	L	1	2	3	4																							
↓	↓	↓	↓	↓	↓																							
2	1	8	not used	6	4																							
Horstmann Channel Plus H21, H27	<table border="1" style="margin: auto; border-collapse: collapse;"> <tr><td>E</td><td>N</td><td>L</td><td>1</td><td>2</td><td>3</td><td>4</td><td>5</td><td>6</td></tr> <tr><td>↓</td><td>↓</td><td>↓</td><td>↓</td><td>↓</td><td>↓</td><td>↓</td><td>↓</td><td>↓</td></tr> <tr><td>*</td><td>2</td><td>1</td><td>6</td><td></td><td>8</td><td>4</td><td></td><td>not used</td></tr> </table>	E	N	L	1	2	3	4	5	6	↓	↓	↓	↓	↓	↓	↓	↓	↓	*	2	1	6		8	4		not used
E	N	L	1	2	3	4	5	6																				
↓	↓	↓	↓	↓	↓	↓	↓	↓																				
*	2	1	6		8	4		not used																				
Note: *Earth not required, Link L - 2 - 5																												
Siemens-Landis & Staefa RWB2, RWB9	<table border="1" style="margin: auto; border-collapse: collapse;"> <tr><td>N</td><td>L</td><td>1</td><td>2</td><td>3</td><td>4</td></tr> <tr><td>↓</td><td>↓</td><td>↓</td><td>↓</td><td>↓</td><td>↓</td></tr> <tr><td>2</td><td>1</td><td>8</td><td>not used</td><td>6</td><td>4</td></tr> </table>	N	L	1	2	3	4	↓	↓	↓	↓	↓	↓	2	1	8	not used	6	4									
N	L	1	2	3	4																							
↓	↓	↓	↓	↓	↓																							
2	1	8	not used	6	4																							
Potterton Myson EP 2001, EP 3001, EP 6002	<table border="1" style="margin: auto; border-collapse: collapse;"> <tr><td>E</td><td>N</td><td>L</td><td>1</td><td>2</td><td>3</td><td>4</td><td>5</td></tr> <tr><td>↓</td><td>↓</td><td>↓</td><td>↓</td><td>↓</td><td>↓</td><td>↓</td><td>↓</td></tr> <tr><td>⊕</td><td>2</td><td>1</td><td>8</td><td>not used</td><td>6</td><td>4</td><td></td></tr> </table>	E	N	L	1	2	3	4	5	↓	↓	↓	↓	↓	↓	↓	↓	⊕	2	1	8	not used	6	4				
E	N	L	1	2	3	4	5																					
↓	↓	↓	↓	↓	↓	↓	↓																					
⊕	2	1	8	not used	6	4																						
Note: Link L - 5																												
Sunvic Select 207	<table border="1" style="margin: auto; border-collapse: collapse;"> <tr><td>N</td><td>L</td><td>1</td><td>2</td><td>3</td><td>4</td></tr> <tr><td>↓</td><td>↓</td><td>↓</td><td>↓</td><td>↓</td><td>↓</td></tr> <tr><td>2</td><td>1</td><td>8</td><td>not used</td><td>6</td><td>4</td></tr> </table>	N	L	1	2	3	4	↓	↓	↓	↓	↓	↓	2	1	8	not used	6	4									
N	L	1	2	3	4																							
↓	↓	↓	↓	↓	↓																							
2	1	8	not used	6	4																							

CONNECTION DETAILS BETWEEN
PROGRAMMER AND WIRING CENTRE

Fig. 11

5 Commissioning

5.1 Filling Secondary DHW Circuit

NOTE: Do not manually open the temperature and pressure relief valve or expansion relief valve for venting purposes (any foreign matter in the pipework may cause damage to the valve seats).

Ensure that the cylinder drain valve (9, fig. 6) is closed.

Open all the hot and cold water taps or other terminal fittings.

Open the mains water supply to the Glow-worm cylinder and continue filling until water runs freely from the terminal fittings, ensuring all air pockets are purged.

Close the terminal fittings and check the system for leaks. Specially check the connection of the immersion heater for leaks.

The system should now be thoroughly flushed.

Open hot water taps at opposite ends of the system and allow water to discharge for at least 5 minutes.

Close the hot water taps.

5.2 Filling the Primary Circuit.

NOTE: Do not use boiler pressure relief valve for venting purpose.

The complete primary CH system must be flushed out with both cold and hot water. Fill and vent the central heating system as detailed in the boiler installation instructions.

To assist with this operation set the manual override lever on the 2 port diverter valve (fig. 7) to the MANUAL position, and lock in this position by pushing the lever into the valve head.

Completely drain the CH system, then refill and vent.

Reset the lever on the 2 port valve to the "AUTO" position by releasing the manual operating lever from the valve head (pull outwards). For commissioning purposes and to reduce the time for the cylinder contents to reach temperature, set the cylinder hot water thermostat knob to setting middle position (approx. 40°C).

Operate the boiler as in section 5.3 until both the cylinder has reached temperature and all radiators in the system are hot. Then once again drain the complete CH system to remove residues from the pipework and refill and vent again as above.

Reset the manual operating lever on the 2 port valve to the "AUTO" position once the system has been refilled and vented.

5.3 Operating the Boiler

Ensure the boiler mains switch is turned on.

Ensure that the programmer and thermostats are calling for heat.

Check that the boiler fires and heats the cylinder contents and the radiators according to the DHW and room thermostat settings.

Carry out the commissioning and testing procedures detailed in the installation instructions supplied with the boiler.

Upon completion of the commissioning procedures, set the DHW thermostat knob on the Glow-worm cylinder to setting 5-6, approx. 60°C, and set the back up immersion heater (fig. 9) thermostat to 60°C.

5.4 Benchmark Log Book

Complete the Benchmark Log Book included in the instructions.

5.5 User's Instructions

Hand these instructions for use to the user for retention and instruct in the safe operation of the boiler and cylinder. Advise the user of the operation of the cylinder thermostat and the immersion heater thermostat, and that normally a setting of max, which gives a stored water temperature of approximately 60°C is adequate.

NOTE: In hard water areas the DHW temperature setting should not exceed this setting to avoid possible scale build-up.

Advise the user of the precautions necessary to prevent damage to the system and to the building if the system does not remain operative during frost conditions.

Advise the user that the immersion heater is provided as a back up means of water heating and is not intended for use at the same time that the boiler is heating the cylinder.

Finally, advise the user that for continued efficient and safe operation, the boiler and Glow-worm cylinder should be serviced at least once a year by a qualified servicing company. It is important and strongly recommended that arrangements are made for a maintenance agreement with a qualified servicing company to ensure regular servicing of the boiler and cylinder.

Please contact Glow-worm's Own Service Organisation (01773-828100) for further details.

NOTE: Leave installation, servicing and user instructions with the user.

6 Maintenance

The following maintenance work has to be carried out annually by the **competent installer** or Glow-worm's Own Service Organisation.

Inspection of pressure/temperature relief valve and expansion relief valve.

Manually operate each valve by twisting the operating cap, and check if water flows unobstructed via the tundish to the discharge point. Ensure that both valves re-seat satisfactorily.

Check pressure of expansion vessel.

Turn off mains water supply and open nearest hot water tap to depressurise the secondary water system.

Check the expansion vessel charge with a pressure gauge at the test point. If the pressure is below 3.0 bar, top up with suitable air pressure pump.

Servicing procedures for the Glow-worm boiler are contained in the boiler installation and servicing instructions.

Complete the service section of Benchmark Log Book.

NOTE: In the event that parts require replacement, use only genuine spare parts supplied by Glow-worm.

7 Fault Finding

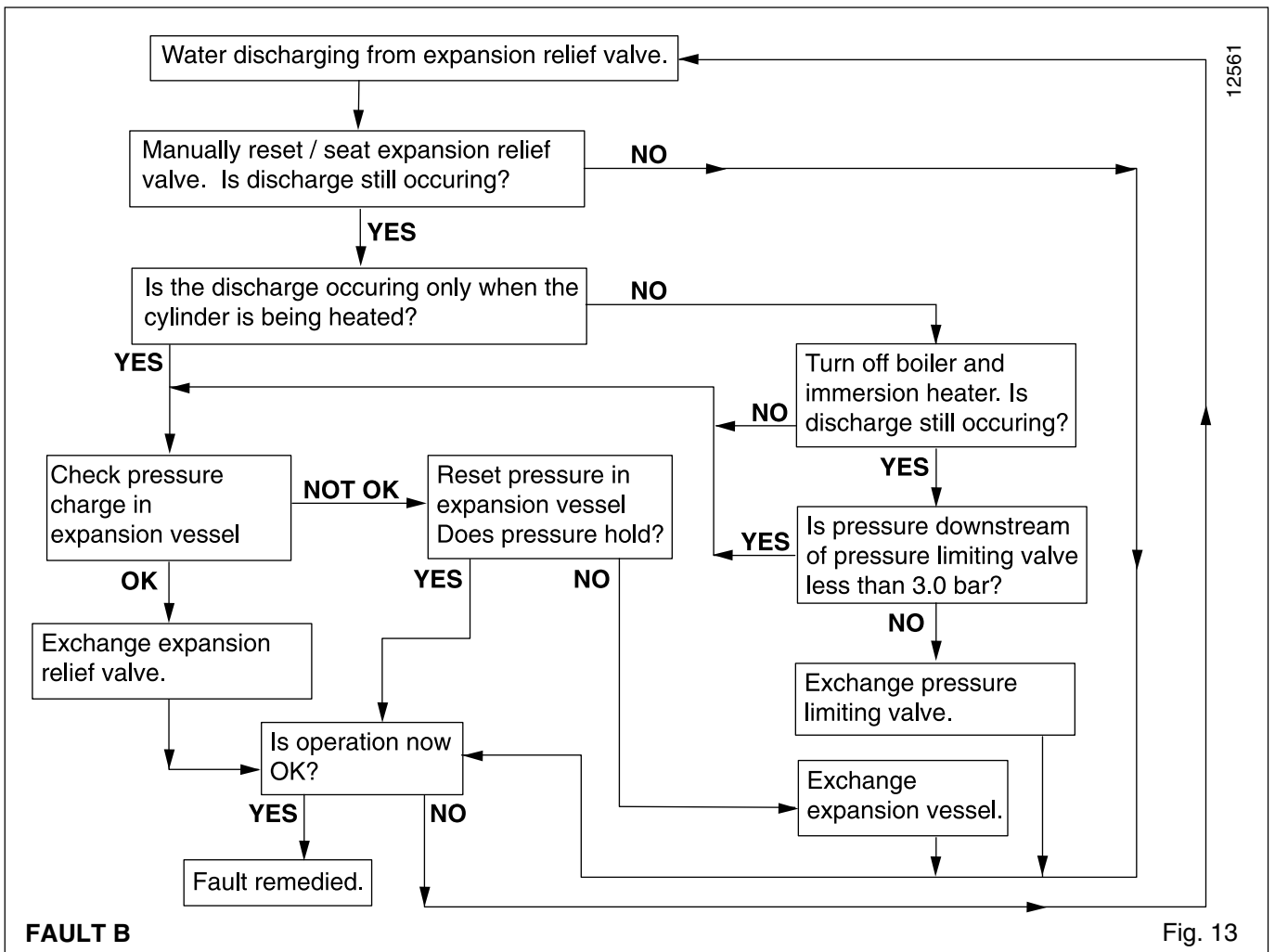
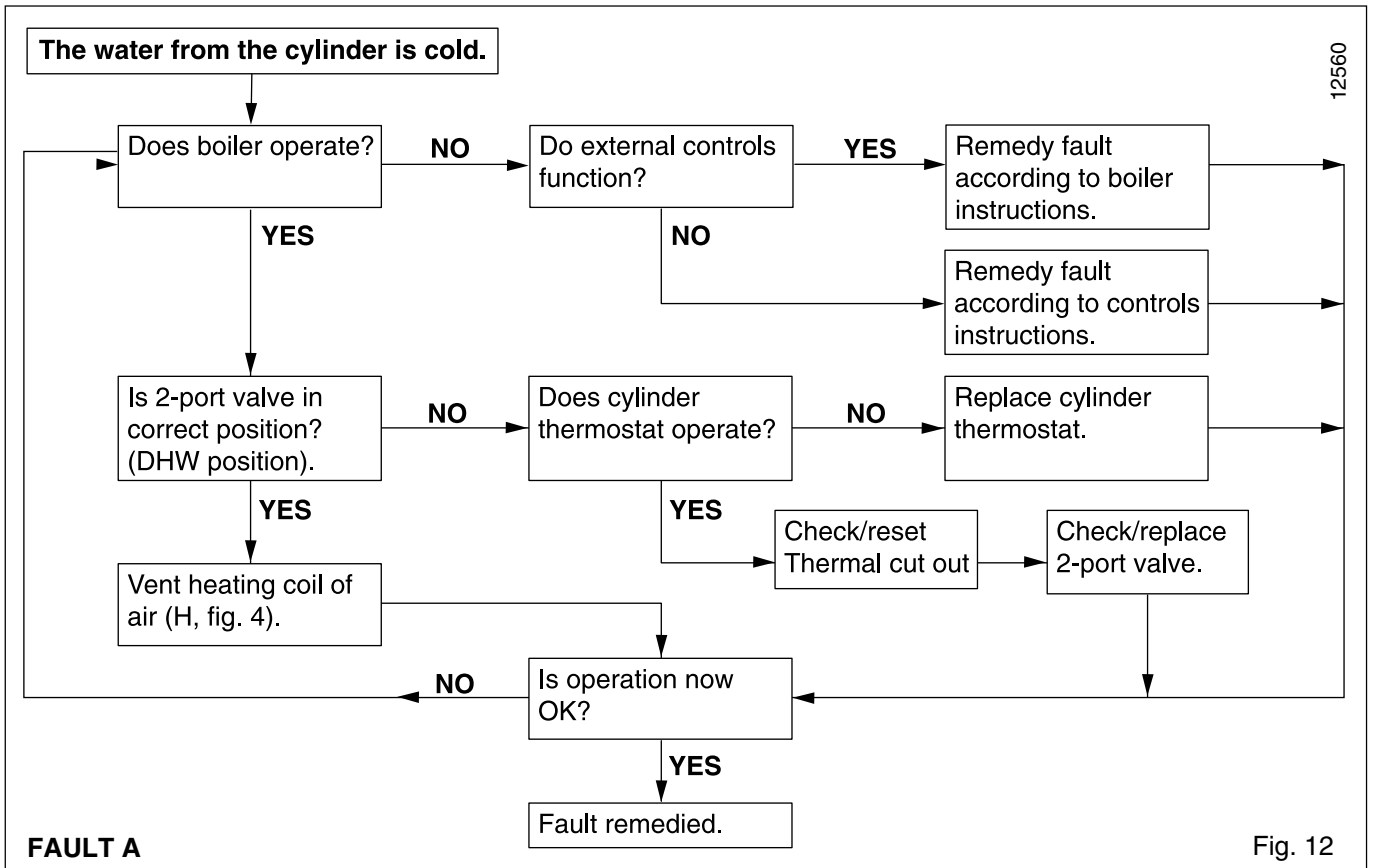

7 Fault Finding

12564

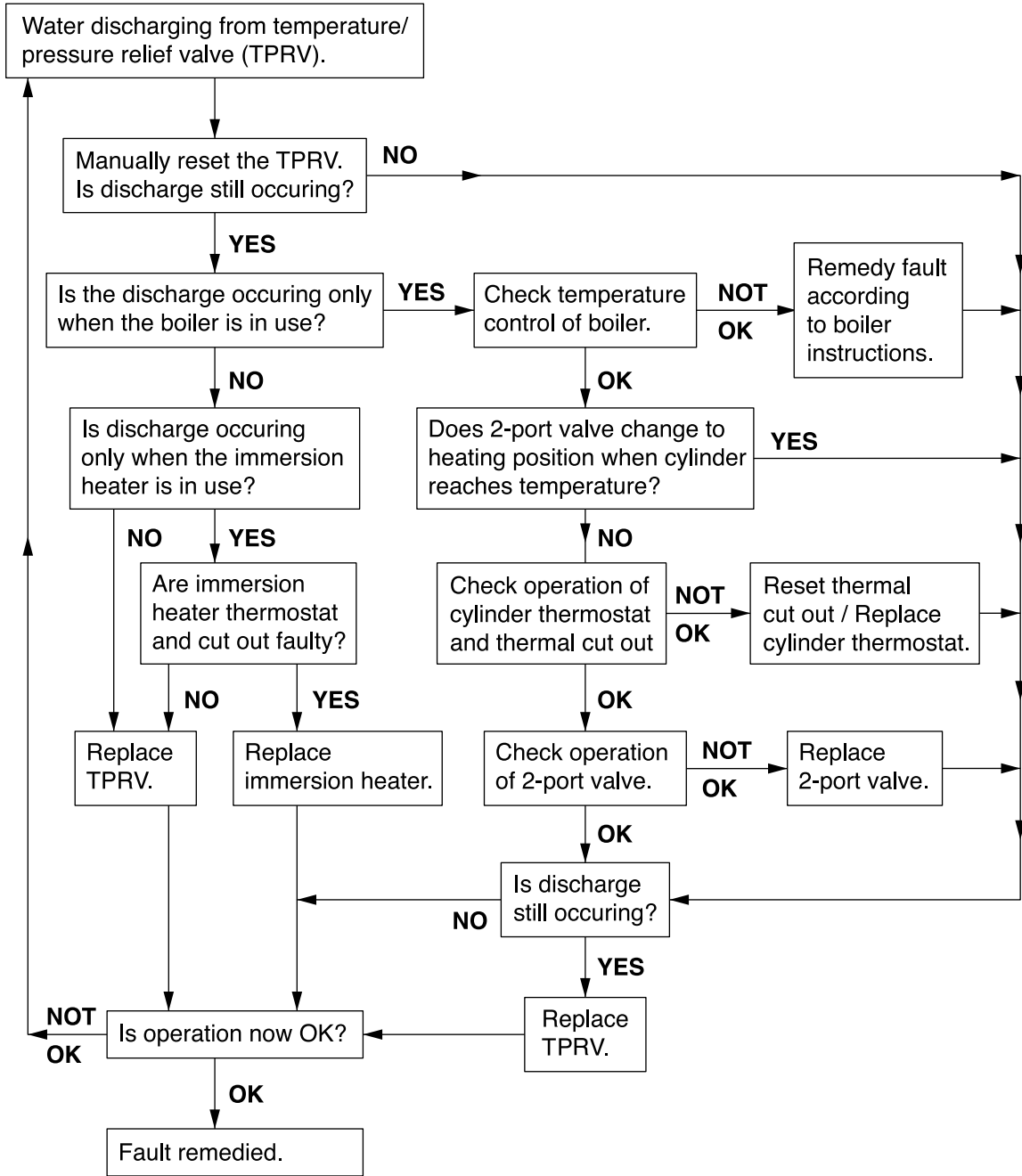

FAULT C

Fig. 14

7 Fault Finding

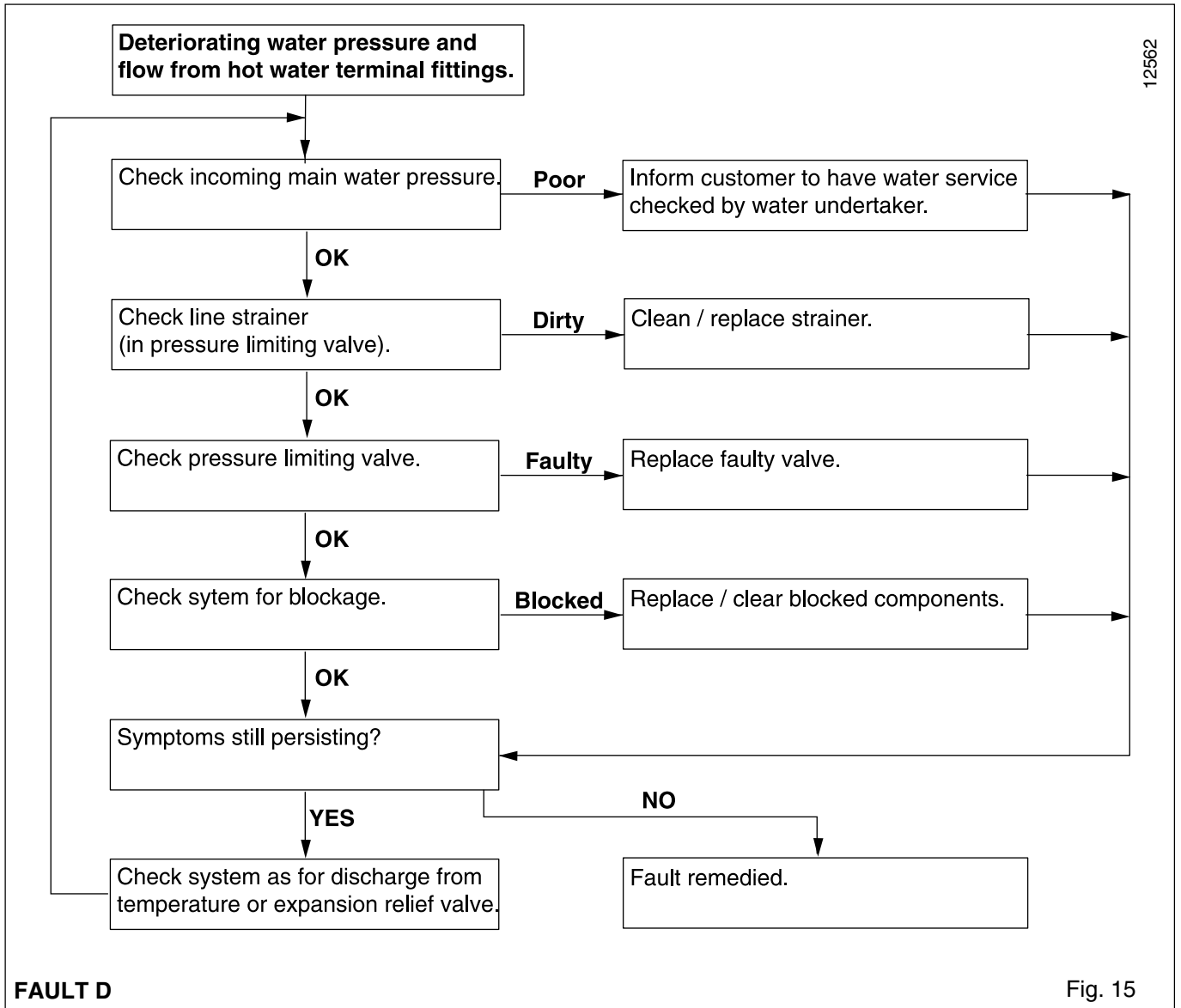

Because of our constant endeavour for improvement, details may vary slightly from those shown in these instructions.